

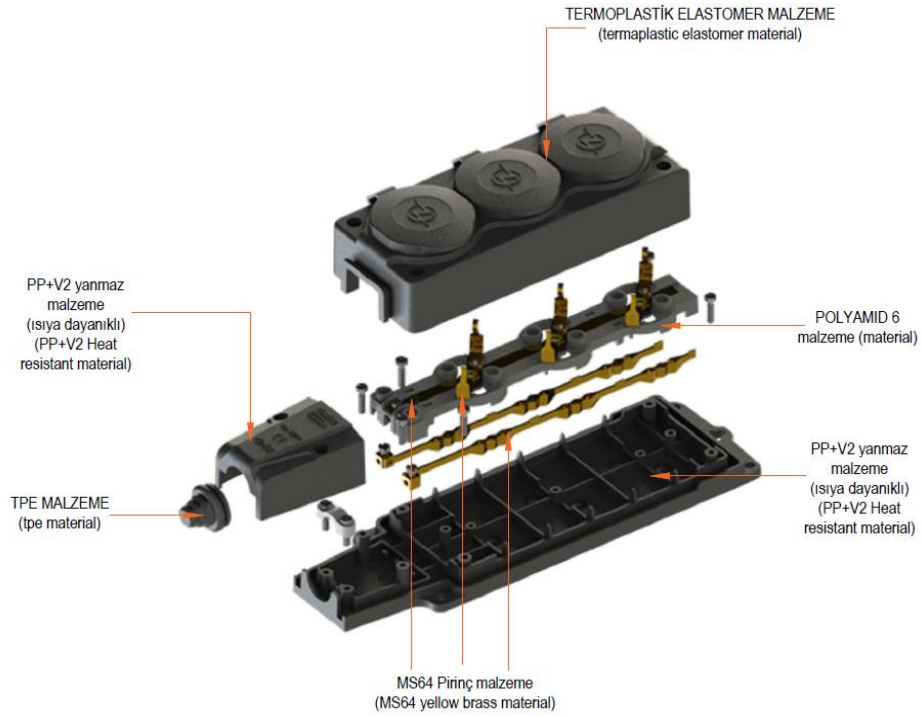

Ürün Kodu / Product Code: 41X3

Genel Teknik Bilgiler / General Technical Informations



Genel Teknik Ölçüler / General Technical Dimensions

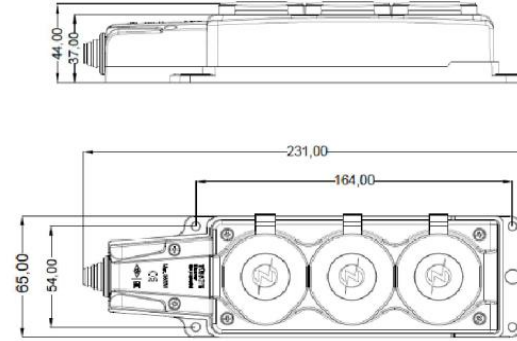

Genel Teknik Bilgiler / General Technical Informations

Akım / Flow: 16A

Volt : 220-250V~

Kutup / Pole : 2P+E

Koruma Sınıfı / Protection Class: IP44

